

Technical information Valve Face-to-Face (FTF) dimension



Valve Face-to-Face (FTF) dimension

ANSI B16.10 Raised Face

Size		Class 150				Class 300				Class 600		Class 900		Class 1500		Class 2500	
Inch	DN	Short Pattern		Long Pattern		Short Pattern		Long Pattern		Long Pattern		Long Pattern					
		mm	inch	mm	inch	mm	inch	mm	inch	mm	inch	mm	inch	mm	inch	mm	inch
1/2"	15	108.00	4.25	108.00	4.25	140.00	5.50	140.00	5.50	165.00	6.50	216.00	8.50	216.00	8.50	264.00	10.38
3/4"	20	117.00	4.62	117.00	4.62	152.00	6.00	152.00	6.00	190.00	7.50	229.00	9.00	229.00	9.00	273.00	10.75
1"	25	127.00	5.00	127.00	5.00	165.00	6.50	165.00	6.50	216.00	8.50	254.00	10.00	254.00	10.00	308.00	12.12
1 1/4"	32	140.00	5.50	140.00	5.50	178.00	7.00	178.00	7.00	229.00	9.00	279.00	11.00	279.00	11.00	349.00	13.75
1 1/2"	40	165.00	6.50	165.00	6.50	190.00	7.50	190.00	7.50	241.00	9.50	305.00	12.00	305.00	12.00	384.00	15.12
2"	50	178.00	7.00	178.00	7.00	216.00	8.50	216.00	8.50	292.00	11.50	368.00	14.50	368.00	14.50	451.00	17.75
2 1/2"	65	190.00	7.50	190.00	7.50	241.00	9.50	241.00	9.50	330.00	13.00	419.00	16.50	419.00	16.50	508.00	20.00
3"	80	203.00	8.00	203.00	8.00	282.00	11.12	282.00	11.12	356.00	14.00	381.00	15.00	470.00	18.50	578.00	22.75
4"	100	229.00	9.00	229.00	9.00	305.00	12.00	305.00	12.00	432.00	17.00	457.00	18.00	546.00	21.50	673.00	26.50
6"	150	267.00	10.50	394.00	15.50	403.00	15.88	403.00	15.88	559.00	22.00	610.00	24.00	705.00	27.75	914.00	36.00
8"	200	292.00	11.50	457.00	18.00	419.00	16.50	502.00	19.75	660.00	26.00	737.00	29.00	832.00	32.75	1022.00	40.25
10"	250	330.00	13.00	533.00	21.00	457.00	18.00	568.00	22.38	787.00	31.00	838.00	33.00	991.00	39.00	1270.00	50.00
12"	300	356.00	14.00	610.00	24.00	502.00	19.75	648.00	25.50	838.00	33.00	965.00	38.00	1130.00	44.50	1422.00	56.00
14"	350	381.00	15.00	686.00	27.00	572.00	22.50	762.00	30.00	889.00	35.00	1029.00	40.50	1257.00	49.50	-	-
16"	400	406.00	16.00	762.00	30.00	610.00	24.00	838.00	33.00	991.00	39.00	1130.00	44.50	1384.00	54.50	-	-

ANSI B16.10 Ring Type Joint (RTJ)

Size		Class 150				Class 300				Class 600		Class 900		Class 1500		Class 2500	
Inch	DN	Short Pattern		Long Pattern		Short Pattern		Long Pattern		Long Pattern		Long Pattern					
		mm	inch	mm	inch	mm	inch	mm	inch	mm	inch	mm	inch	mm	inch	mm	inch
1/2"	15	108.00	4.25	108.00	4.25	151.00	5.94	151.00	5.94	163.00	6.44	216.00	8.50	216.00	8.50	264.00	10.38
3/4"	20	117.00	4.62	117.00	4.62	165.00	6.50	165.00	6.50	190.00	7.50	229.00	9.00	229.00	9.00	273.00	10.75
1"	25	140.00	5.50	140.00	5.50	178.00	7.00	178.00	7.00	216.00	8.50	254.00	10.00	254.00	10.00	308.00	12.12
1 1/4"	32	153.00	6.00	153.00	6.00	191.00	7.50	191.00	7.50	229.00	9.00	279.00	11.00	279.00	11.00	352.00	13.87
1 1/2"	40	178.00	7.00	178.00	7.00	203.00	8.00	203.00	8.00	241.00	9.50	305.00	12.00	305.00	12.00	387.00	15.24
2"	50	191.00	7.50	191.00	7.50	232.00	9.12	232.00	9.12	295.00	11.62	371.00	14.62	371.00	14.62	454.00	17.87
2 1/2"	65	203.00	8.00	203.00	8.00	257.00	10.12	257.00	10.12	333.00	13.12	422.00	16.62	422.00	16.62	514.00	20.25
3"	80	216.00	8.50	216.00	8.50	298.00	11.74	298.00	11.74	359.00	14.12	384.00	15.12	473.00	18.62	584.00	23.00
4"	100	242.00	9.50	242.00	9.50	321.00	12.62	321.00	12.62	435.00	17.12	460.00	18.12	549.00	21.62	683.00	26.88
6"	150	280.00	11.00	407.00	16.00	419.00	16.50	419.00	16.50	562.00	22.12	613.00	24.12	711.00	28.00	927.00	36.50
8"	200	305.00	12.00	470.00	18.50	435.00	17.12	518.00	20.37	663.00	26.12	740.00	29.12	842.00	33.13	1038.00	40.87
10"	250	343.00	13.50	546.00	21.50	473.00	18.62	584.00	23.00	790.00	31.12	841.00	33.12	1001.00	39.38	1292.00	50.88
12"	300	369.00	14.50	623.00	24.50	518.00	20.37	664.00	26.12	841.00	33.12	968.00	38.12	1146.00	45.12	1444.00	56.88
14"	350	394.00	15.50	699.00	27.50	588.00	23.12	778.00	30.62	892.00	35.12	1039.00	40.88	1276.00	50.25	-	-
16"	400	419.00	16.50	775.00	30.50	626.00	24.62	854.00	33.62	994.00	39.12	1140.00	44.88	1406.00	55.38	-	-

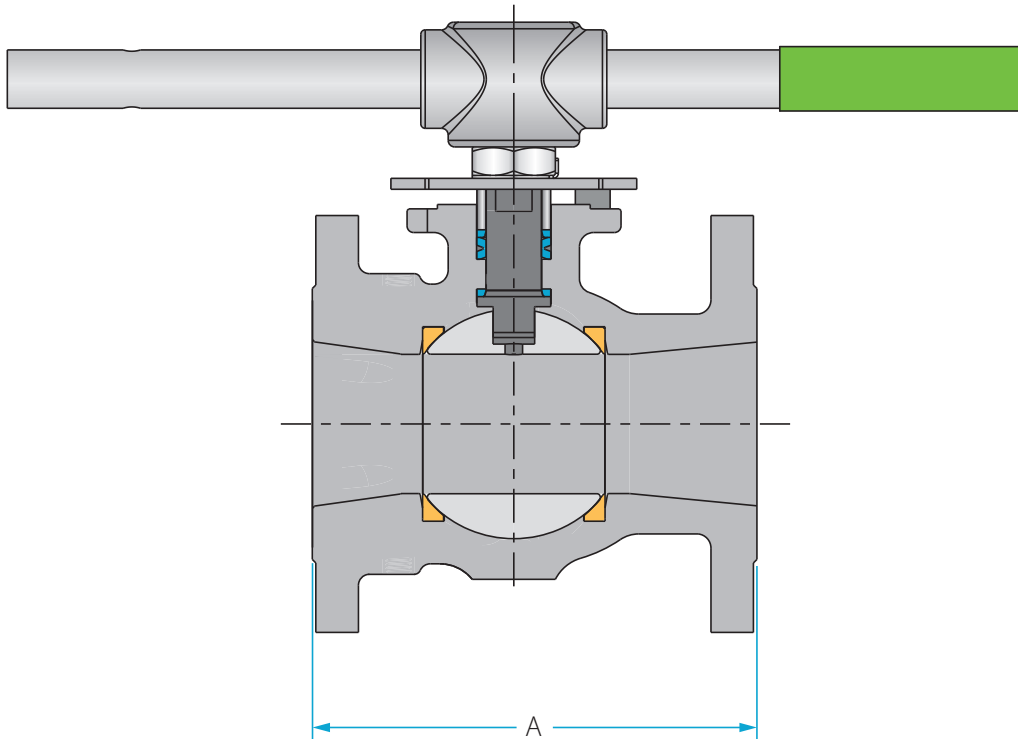

DIN 3202-1 Raised Face

Size		F1		F2		F4		F5	
Inch	DN	mm	inch	mm	inch	mm	inch	mm	inch
1/2"	15	130.00	5.12	210.00	8.27	115.00	4.53	-	-
3/4"	20	150.00	5.91	230.00	9.06	120.00	4.72	-	-
1"	25	160.00	6.30	230.00	9.06	125.00	4.92	120.00	4.72
1 1/4"	32	180.00	7.09	260.00	10.24	130.00	5.12	140.00	5.51
1 1/2"	40	200.00	7.87	260.00	10.24	140.00	5.51	240.00	9.45
2"	50	230.00	9.06	300.00	11.81	150.00	5.91	250.00	9.84
2 1/2"	65	290.00	11.42	340.00	13.39	170.00	6.69	270.00	10.63
3"	80	310.00	12.20	380.00	14.96	180.00	7.09	280.00	11.02
4"	100	350.00	13.78	430.00	16.93	190.00	7.48	300.00	11.81
6"	150	480.00	18.90	550.00	21.65	210.00	8.27	350.00	13.78
8"	200	600.00	23.62	650.00	25.59	230.00	9.06	400.00	15.75
10"	250	730.00	28.74	775.00	30.51	250.00	9.84	450.00	17.72
12"	300	850.00	33.46	900.00	35.43	270.00	10.63	500.00	19.69
14"	350	980.00	38.58	1025.00	40.35	290.00	11.42	550.00	21.65
16"	400	1100.00	43.31	1150.00	45.28	310.00	12.20	600.00	23.62



www.habonim.com

Habonim ISRAEL

Tel: +972-4-6914911

Fax: +972-4-6914935

sales_international@habonim.com

Habonim EUROPE

Tel: +34 640 384 759

sales_eu@habonim.com

Habonim UK

Tel: +44-1633-484554

Fax: +44-1633-482252

sales_uk@habonim.com

Habonim USA

Toll Free Phone: 1-866-261-8400

Toll Free Fax: 1-866-243-9959

sales_usa@habonim.com

Habonim CHINA

Tel: + 86 21 64453190 *146

sales_china@habonim.com

Habonim AUSTRALIA

Tel: +61 3 9556 5428

sales_au@habonimau.com



www.habonim.com

MAXMARK Technical Information-FTF 02/17 REV2.03

MAXMARK

