

# HABONIM

## Cryogenic valves Series

## Installation, Operating & Maintenance

### Series Included:

**C47C, C31C, C32C,  
C73C, C74C, C77C, C78C**

Standard bore and full bore (CB),  
Fire-Safe (FC) and non Fire-Safe

### Sizes Included:

**1/2" - 6" (DN15 – DN150)**

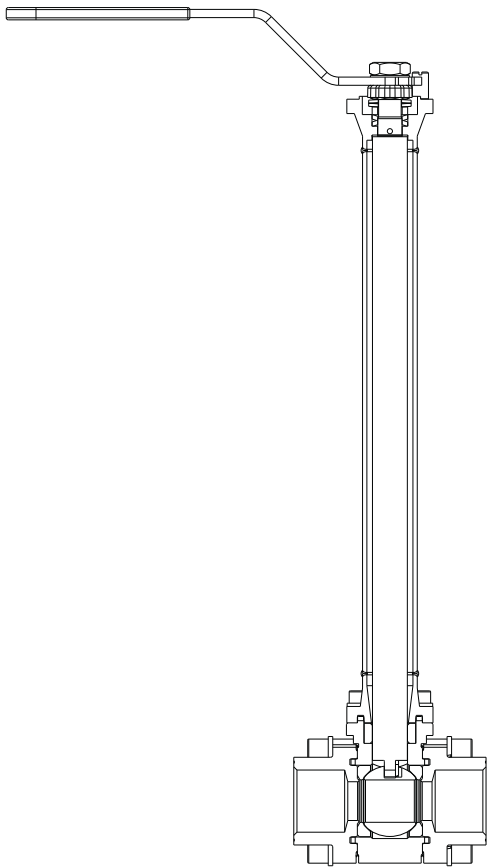

### 1. GENERAL

This Installation, Operating & Maintenance manual covers the instructions required for safe use of Habonim cryogenic ball valve.

Before using a valve, read the entire IOM carefully and make sure you understand everything.

### WARNINGS & SAFETY INSTRUCTIONS

Habonim cannot anticipate all of the situations a user may encounter while installing and using Habonim valves. The user **MUST** know and follow all applicable industry specifications on the safe installation and use of these valves. Misapplication of the product may result in injuries or property damage. Refer to Habonim product catalogues, product brochures and installation, operating and maintenance manuals for additional product safety information or contact Habonim technical service.

1. Keep hands and objects away from the valve ports at all times. Actuated valves could be accidentally operated, resulting in serious injury or valve damage.
2. Before removing a valve from the line always make sure the line has been depressurized and drained.
3. Utmost caution must be taken when handling a valve that has toxic, corrosive, flammable or a contaminant nature media flowing through its pipeline. The following safety precautions are recommended when dismantling valves with hazardous media:
  - a. Wear eye shield, protective headgear, clothing, gloves and footwear.
  - b. Have available running water.
  - c. Have a suitable fire extinguisher when media is flammable.
4. Do not try to operate a valve that exhibits any sign of leakage. Isolate the valve and either repair or replace it.
5. Do not use or substitute non Habonim components or parts in Habonim valves and assemblies.



Kfar Hanassi, Upper Galilee 12305 Israel  
Tel: 972 - 4 - 6914911  
Fax: 972 - 4 - 6914902  
E-Mail: [habonim@habonim.co.il](mailto:habonim@habonim.co.il)  
[www.habonim.com](http://www.habonim.com)

DEDICATED TO INNOVATION

**2. LIMITATIONS**

The correct selection of materials of construction, seats and seals, internal valve components and pressure/temperature ratings determines the safe use of the valves and the particular performance requirements for the application. This information can be found on the nameplate welded to the valve body.

The combined corrosion and erosion allowance for the valve body wall thickness is 1 mm. When this allowance has gone, the valve should no longer be used. Inspect the valve wall thickness every time the valve is maintained. Refer to Habonim Corrosion Data Chart T-614 to determine the corrosion rate for your application. As the variety of applications these valves can be used in is large, it is impossible to cover all installation and maintenance instructions for servicing the valves. It is the owner's responsibility to use the valves as recommended and in accordance with the pressure and temperature limits as stated in this manual. Where in doubt, please consult with Habonim.

Any unstable fluid or gas should be identified by its manufacturer and must not be used with Habonim valves.

**CAUTION:**

The valves should be used in a well designed, adequately protected system to ensure that pressure and temperature limits are not exceeded.

Valve surface temperature may become extremely cold due to operating conditions. Prevent any type of direct contact with the valve that may harm the workers.

The valves should be used in a well designed, adequately supported piping system such that it will not be subjected to undue forces or hydraulic shocks during service.

The valves are not designed to operate during or after earthquakes or under fatigue conditions. It is the responsibility of the owner to determine if fatigue conditions exist.

**3. STORAGE**

Prior to storage, inspect the valve for shipping damage. The valves are individually packed in a hermetically sealed polyethylene bag filled with dry nitrogen. It is recommended to keep the valves in their bags and in a clean and protective environment until ready for use. Keep all protective packaging, flange covers and end caps attached to the valves during storage.

**4. INSTALLATION**

**Caution: DO NOT install Cryogenic valves with the extended bonnet tilted more than 45° from the upright vertical position. (see figure 1)**

**FIGURE 1**  
Valve Tilting Limitation

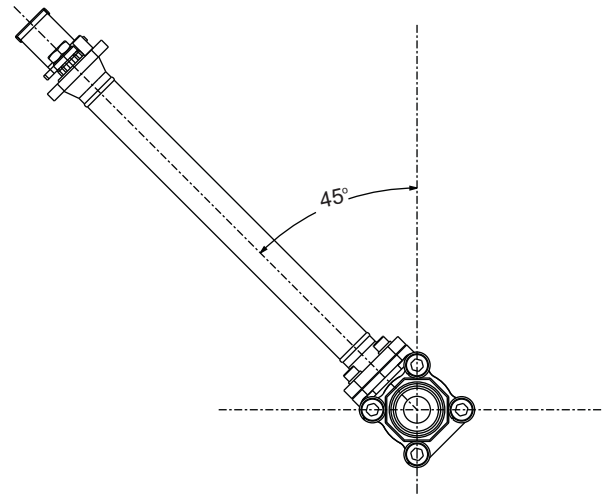

**4.1 General**

**4.1.1** Keep the valve in its polyethylene bag until ready for use. Check the valve nameplate for identification of materials (see Figure 2).

**FIGURE 2**  
Valve Marking and Labeling

All valve marking are on a nameplate which is spot welded to the valve body. Valves for the European market and above 1" carry the CE mark with the information required by the PED.

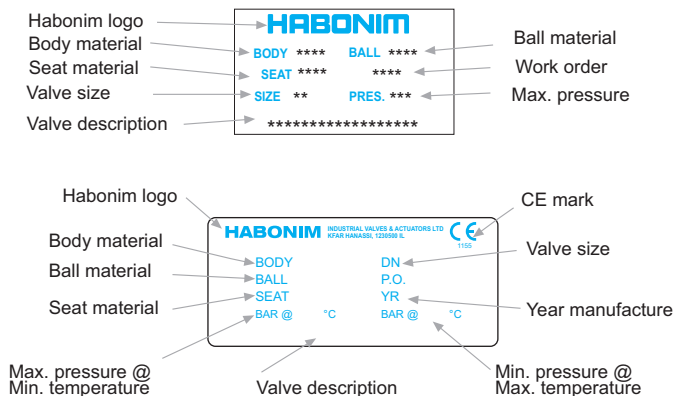

**4.1.2** All Habonim cryogenic valves are uni-directional and must be installed for flow in one direction as indicated by the flow arrow welded on the body and bonnet pad. Usually the arrow points to the shutoff direction of the valve. In some cases where it is not clear, relate to the arrow head as the low pressure side and the arrow tail as the high pressure side.

- 4.1.3 When the valve is in the closed position the ball relief hole will be seen in the upstream port of the valve as indicated by the arrow. The stem head has an engraved "T" mark identifying the ball port and the pressure relief hole direction (See Figure 3).

**FIGURE 3**  
**Valve Top View**

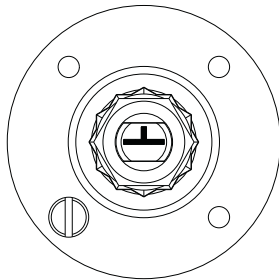

- 4.1.4 Inspect the valve interior through the end ports to determine that it is clean and free from foreign matter.
- 4.1.5 Cycle the valve and inspect any functionally significant features.
- 4.1.6 Read all the literature, and note any special warning tags or plates attached to the valve.
- 4.1.7 During installation, it is recommended that the valve ball be left in the open position to prevent possible damage to the ball.

**4.2 Threaded End Valves**

- 4.2.1 Valves with screwed ends should be treated as a single unit and should not be dismantled when installing to the pipeline.
- 4.2.2 Before installing the valve, make sure that the threads on the mating pipe are free from excessive grit, dirt or burrs.
- 4.2.3 When tightening the valve, apply a pipe wrench or spanner to the end connector closest to the pipe being worked, using standard piping practices.
- 4.2.4 Use appropriate joint sealing materials in correct quantities.
- 4.2.5 If "back-welding" is required on screwed valves, refer to the instructions for Weld End valves or to the "Habonim Welding Instructions" bulletin.

**4.3 In-line welding**

- 4.3.1 Cryogenic valves suitable for in-line welding are designed with extended ends. Habonim ends identification code XBW, ETO.  
(Socket welding is not recommended for Cryogenic use)
- 4.3.2 Welding of valves shall be performed by a qualified welder according to the ASME Boiler Construction Code Section IX. For valves to be welded within the EEA, refer to the requirements of ESR 3.1.2 of the Pressure Equipment Directive 97/23/EC.

- 4.3.3 Valves must be in the fully open position to protect the ball and seats from excessive temperatures during the welding procedures.
- 4.3.4 Automated Valves in the "Fail Close" position should be cycled to the open position.
- 4.3.5 Use a temperature stick and a wet cloth wrapped around the center section to prevent overheating. **DO NOT** heat the center section over 150°C (300°F).
- 4.3.6 Align valve to pipe line, ensuring proper fit to minimize pipe load. Tack weld only.
- 4.3.7 Complete welding in small segments. Allow enough time for cooling between each segment.
- 4.3.8 After completing the welds, wait for the valve to cool below 90°C (200°F). Tighten the body bolts to torque figures and tightening patterns according to **Figure 5**
- 4.3.9 It is recommended not to rotate the valve to the closed position before flushing the line.

**4.4 Weld End Valves not in-line**

- 4.4.1 Valves that will be disassembled before welding carry a packet with replacement body seals. Follow steps 2 to 9 of the DISASSEMBLY section but to not discard the seat rings.
- 4.4.2 Prior to welding the ends to the pipe, ensure that the end flats are aligned to the body flats.
- 4.4.3 **Do not scratch or cut the seats and sealing surfaces of the valves as this will cause valve leakage.**
- 4.4.4 Assemble the valve without the ball and seats and follow steps 1 to 7 for Weld End Valves.
- 4.4.5 After the valve cools, again follow steps 2 to 9 of the DISASSEMBLY section and section 7 to 13 of the ASSEMBLY section.

**4.5 Flanged valves**

- 4.5.1 Flanged valves should be installed using flange gaskets appropriate for the intended service. Fire safe valves require high temperature gaskets.
- 4.5.2 Tighten flange bolts evenly to torque values appropriate for the gasket and bolt material.

**5. OPERATION**

- 5.1 Flush the valves and pipeline with nitrogen, whilst preventing the introduction of air, moisture or water into the cryogenic valves and pipelines as this will freeze the valve and render it inoperable.
- 5.2 Habonim Cryogenic Valves provide tight shut off when used in accordance with Habonim published pressure/temperature chart. If these valves are used in a partially open (throttled) position, seat life may be reduced.
- 5.3 Valves are operated by turning the valve handle 90° anti-clockwise to open, and turning 90° clockwise to close.
- 5.4 To prevent leakage or malfunctions resulting from internal wear or seal degradation, the user must establish a preventive maintenance and inspection program.

This program must include:

- a. Inspection of parts to detect loss of wall thickness which may result in decreased pressure capacity.
- b. Routine replacement of seals and inspection for proper operation.

5.5 Valve operating torques as published in the Habonim literature are the normal expected maximum break-away torques. These torques have been confirmed by laboratory testing of each valve under controlled conditions. Highly viscous or abrasive media could cause an increase in valve torque.

**6 MAINTENANCE**

**6.1 GENERAL**

6.1.1 HABONIM valves have a long and trouble free life, and maintenance is seldom required. When maintenance is necessary, valves can be refurbished on site.

6.1.2 To extend valve performance and reduce possible plant problems, the following procedures should be followed:

- o If leakage at the stem is noted, tighten the gland nut about a 1/8-turn as a routine maintenance procedure. This will compensate for any wear or settling of the gland packing.

**Caution:** Excessive tightening of the stem nut can result in accelerated seal wear and high valve operating torque.

- o If the valve is removed from the line and disassembled, replacement of all seats and seals is recommended using the appropriate Habonim Repair kit. Examine all metallic sealing surfaces such as ball, stem, and the surfaces on the end connectors that contact the seats for wear, corrosion or damage.
- o Only Habonim's spare parts should be used. A soft parts repair kit from Habonim consists of the following:
  - 2 x seats
  - 1 x gland packing
  - 1 x stem thrust bearing
  - 1 or 2 x body seals
  - 1 x bonnet seal
  - 1 x stem bearing
- o In addition to soft parts kits, other spare parts available from Habonim are: valve balls, stems, glands, bolts, screws and nuts. Should additional parts be required, it is recommended that the complete valve be replaced.
- o When ordering repair kits, please provide the valve size and full figure number code and series.

**6.2 DISASSEMBLY**

The following instructions are for the in-line disassembly of C47C and FC47C valves (All sizes).

6.2.1 Cycle the valve with the line pressure fully relieved before attempting to remove the valve from the pipeline, to insure pressure has also been discharged from the valve cavity.

6.2.2 Bring the valve handle to the open position.

**Caution:** trying to remove the valve body from the line in the closed position will damage the ball.

6.2.3 With the valve in the open position, remove the body bolts.

6.2.4 Cryogenic valve end connectors are interlocked to the body (see figure 4). To overcome this feature it is necessary to separate the ends from the body using a block of wood or plastic mallet and swing the body out of the line. If the pipe does not allow enough movement, remove the remaining bolts and rotate the body through its port axis, enabling easier access to the end connectors flanges.

**FIGURE 4**  
Cryogenic valve body and interlocked end connector

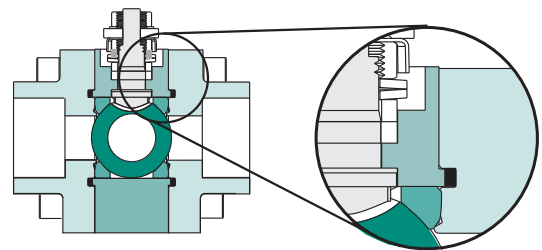

6.2.5 Remove the seat rings and body seals. Be careful not to damage the sealing surfaces of the valve and ends.

6.2.6 Support the ball to prevent it from falling out of the body and turn the handle to the closed position for its removal. Set the ball aside in a clean and secure area for reuse. Loosen the 4 cap screws and remove the extended bonnet from the valve body.

6.2.8 Remove and discard the bonnet seal and the PTFE stem bearing.

6.2.9 Remove the wrench nut, serrated washer, and handle, locking clip, gland nut, disc springs and gland. Place all components removed, in a clean secure area.

6.2.10 Slide the stem and remove it from the extended bonnet. Discard the stem thrust ring and packing, taking care not to scratch or nick the stem or the packing bore area of the bonnet.

The following instructions are for the disassembly of end entry cryogenic flanged valves:

**C31C, FC31C**

**C32C, FC32C (Size 1/2" to 6") #150 Rating**

**C74C, FC74C (Size 1/2" to 1") #300 Rating**

**C78C, FC78C (Size 1/2" to 1") PN40**

6.2.11 Cycle the valve with the line pressure fully relieved before attempting to remove the valve from the pipeline, to insure pressure has also been discharged from the valve cavity.

6.2.12 Loosen all flange bolts and slide the valve out of the pipe line.

6.2.13 Clamp the valve in a vice with the flange insert face up.

- 6.2.14 With the valve in the open position, remove the valve insert using a hexagon shaped key and a pipe extension.
- 6.2.15 Remove and discard the seat rings and body seal. Be careful not to damage the sealing surfaces.
- 6.2.16 Support the ball to prevent it from falling out of the body and turn the handle to the closed position for its removal. Set the ball aside in a clean and secure area for reuse.
- 6.2.17 Loosen the 4 cap screws and remove the extended bonnet from the valve body.
- 6.2.18 Remove and discard the bonnet seal and the PTFE stem bearing.
- 6.2.19 Remove the wrench nut, serrated washer, and handle, locking clip, gland nut, disc springs and gland. Place all components removed, in a clean secure area.
- 6.2.20 Slide the stem and remove it from the extended bonnet. Discard the stem thrust ring and packing, taking care not to scratch or nick the stem or the packing bore area of the bonnet.

The following instructions are for the disassembly of two pcs cryogenic flanged valves:

**C73C, FC73C (Size 1 1/2" to 6") #150 Rating**

**C74C, FC74C (Size 1 1/2" to 6") #300 Rating**

**C78C, FC78C (Size 1 1/2", 2") PN40**

**C77C, FC77C (Size 3", 4", 6") PN16**

- 6.2.21 Cycle the valve with the line pressure fully relieved before attempting to remove the valve from the pipeline, to insure pressure has also been discharged from the valve cavity.
- 6.2.22 Loosen all flange bolts and slide the valve out of the pipe line.
- 6.2.23 Clamp the valve in a vice with the flange end cap face up.
- 6.2.24 With the valve in the open position, release the valve body bolts and remove the end cap. Lay the end cap on the flange side and remove the seat from its place.
- 6.2.25 Remove and discard the seat rings and body seal. Be careful not to damage the sealing surfaces.
- 6.2.26 Support the ball to prevent it from falling out of the body and turn the handle to the closed position for its removal. Set the ball aside in a clean and secure area for reuse.
- 6.2.27 Loosen the 4 cap screws and remove the extended bonnet from the valve body.
- 6.2.28 Remove and discard the bonnet seal and the PTFE stem bearing.
- 6.2.29 Remove the wrench nut, serrated washer, and handle, locking clip, gland nut, disc springs and gland. Place all components removed, in a clean secure area.
- 6.2.30 Slide the stem and remove it from the extended bonnet. Discard the stem thrust ring and packing, taking care not to scratch or nick the stem or the packing bore area of the bonnet.

**6.3 ASSEMBLY**

The following instructions are for the in-line assembly of C47C and FC47C valves.

- 6.3.1 Clean valve parts completely using a cloth and IPA solution.
- 6.3.2 Follow the welded arrow and place the ball inside the body with the pressure relief hole towards the arrow's tail.
- 6.3.3 Place the new seat rings and body seals in the valve body.
- 6.3.4 Hold the end connectors toward the valve body making sure that the tongue and groove valve construction match. Hand tighten the body bolts.
- 6.3.5 Insert the PTFE stem bearing into the valve body top platform
- 6.3.6 Place the stem thrust ring on the stem.
- 6.3.7 Slide the stem into the extended bonnet with the threaded side first and carefully guide it up through the bonnet bore.
- 6.3.8 Insert the seal inside the extended bonnet bottom flange.
- 6.3.9 Holding the exposed stem tip together with the extended bonnet, slide the stem into the ball.

**Note: the unique design will allow only one correct engagement. (see figure 5)**

**FIGURE 5  
Fool Proof Trim Design**

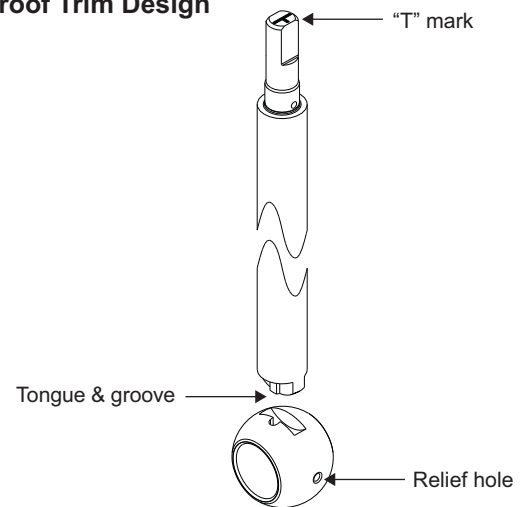

- 6.3.10 With the bottom flange of the bonnet aligned with the valve platform, and with the arrows on the body and bonnet pointing in the same direction, hand tighten the bonnet bolts and spring washers.
- 6.3.11 Tighten the body bolts to the torque figures (table 2), and according to tightening pattern illustrated in figure 6
- 6.3.12 Tighten the bonnet bolts to the torque figures (table 3), and according to tightening pattern illustrated in figure 6.
- 6.3.13 Make sure the valve stem is free to move (0.5 mm) up and down.
- 6.3.14 Holding the stem up insert the new packing over the stem and into the stem bore. Place the metal follower and the two disks spring (face to face) onto the stem.
- 6.3.15 Thread the gland nut onto the stem. Tighten the gland nut to the torque figures (table 1).
- 6.3.16 Place the locking clip on the gland nut by adjusting the orientation of the nut (in the clockwise direction).

- 6.3.17 Place the handle, serrated washer and thread the wrench nut on the stem. Holding the handle tighten the wrench nut tight.
- 6.3.18 Leave the valve in the open position for flushing the line.

The following instructions are for the assembly of end entry cryogenic flanged valves:

**C31C, FC31C, C32C, FC32C (Size 1/2" to 6") #150 Rating**  
**C74C, FC74C (Size 1/2" to 1") #300 Rating**  
**C78C, FC78C (Size 1/2" to 1") PN40**

- 6.3.19 Clean the valve entrance and the insert thread. Apply an anti-seize lubricant on the insert thread and screw it to the valve body (Hand-tight) until it reaches the thread end. At this point the insert should be 0.2 mm above the valve raised face. Mark a straight line across the valve and insert to indicate the final screwed position for use later. Remove the insert from the valve body.
- 6.3.20 Insert one seat ring into the valve cavity with its round profile facing up.
- 6.3.21 Follow the arrow mark on the body and place the ball inside the valve with the pressure relief hole towards arrow's tail and with the ball groove face up.
- 6.3.22 Place the second seat ring and body seal inside the valve body.
- 6.3.23 Using a hexagonal key, thread the insert (hand tight) into the valve body.
- 6.3.24 Locate the PTFE stem bearing inside the valve top platform.
- 6.3.25 Place the stem thrust ring on the stem.
- 6.3.26 Slide the stem into the extended bonnet with the threaded side first and carefully guides it up through the bonnet bore.
- 6.3.27 Insert the seal inside the extended bonnet bottom flange.
- 6.3.28 Holding the exposed stem tip together with the extended bonnet, slide the stem into the ball.  
**Note: the unique design will allow only one correct engagement. (see figure 4)**
- 6.3.29 With the bottom flange of the bonnet aligned with the valve platform, and with the arrows on the body and bonnet pointing in the same direction, hand tighten the bonnet bolts and spring washers.
- 6.3.30 Tighten the bonnet bolts to the torque figures (table 3), and according to tightening pattern illustrated in figure 6.
- 6.3.31 Make sure the valve stem is free to move (0.5 mm) up and down.
- 6.3.32 Using a hexagonal key and extension pipe, and tighten the insert firmly to its present mark as described in 6.3.21 of this section. It is acceptable for it to be, up to 20 mm to the left of the body mark.
- 6.3.33 Holding the stem, insert the new packing over the stem and into the stem bore. Place the metal follower and the two disk springs (face to face) onto the stem.
- 6.3.34 Thread the gland nut onto the stem. Tighten the gland nut to the torque figures (table 1).
- 6.3.35 Place the locking clip on the gland nut by adjusting the orientation of the nut (in a clockwise direction only).
- 6.3.36 Place the handle, serrated washer and thread the wrench nut onto the stem. while holding the handle, tighten the wrench nut tightly.
- 6.3.37 Leave the valve in the open position for flushing the line.

The following instructions are for the assembly of two pcs cryogenic flanged valves:

**C73C, FC73C (Size 1 1/2" to 6") #150 Rating**  
**C74C, FC74C (Size 1 1/2" to 6") #300 Rating**  
**C78C, FC78C (Size 1 1/2", 2") PN40**  
**C77C, FC77C (Size 3", 4", 6") PN16**

- 6.3.38 Insert one seat ring into the valve cavity with its round profile facing up.
- 6.3.39 Follow the arrow mark on the body and place the ball inside the valve with the pressure relief hole towards arrows tail and with the ball groove face up.
- 6.3.40 Place the body seal inside the valve cavity.
- 6.3.41 Lay the end cap and its seat on the ball, align it to the body bolt holes, making sure that the body flange and end cap flange are correctly oriented.
- 6.3.42 Apply an anti-galling lubricant, then insert the body bolts and hand tighten them.
- 6.3.43 Locate the PTFE stem bearing inside the top of the valve platform.
- 6.3.44 Place the stem thrust ring on the stem.
- 6.3.45 Slide the stem into the extended bonnet with the threaded side first and carefully guides it up through the bonnet bore.
- 6.3.46 Insert the seal inside the bottom flange of the extended bonnet.
- 6.3.47 Holding the exposed stem tip together with the extended bonnet, slide the stem into the ball.  
**Note: the unique design will only allow for one correct engagement. (see figure 4)**
- 6.3.48 With the bottom flange of the bonnet aligned with the valve platform, and with the arrows on the body and bonnet pointing in the same direction, hand tighten the bonnet bolts and spring washers.
- 6.3.49 Tighten the bonnet bolts to the torque figures (table 3), and according to tightening pattern illustrated in figure 6.
- 6.3.50 Make sure the valve stem is free to move (0.5 mm) up and down.
- 6.3.51 Tighten the body bolts evenly to the torque figures in (table 2) using the proper tool.
- 6.3.52 Holding the stem insert the new packing over the stem and into the stem bore. Place the metal follower and the two disk springs (face to face) onto the stem.
- 6.3.53 Thread the gland nut onto the stem. Tighten the gland nut to the torque figures (table 1).
- 6.3.54 Place the locking clip on the gland nut by adjusting the orientation of the nut (in the clockwise direction).
- 6.3.55 Place the handle, serrated washer and thread the wrenchnut on the stem. Holding the handle tighten the wrench nut tight.
- 6.3.56 Leave the valve in the open position for flushing the line.

**TABLE 1**  
Gland Nut Tightening Torque For C47C, FC47C

Reduce Bore	Full Bore	Nut Thread	PTFE Seals		* Graphite Seals	
			Nm	in.lb	Nm	in.lb
1/2" - 3/4"	1/2"	3/8" UNF-24 UNF	4	35	6-4	53-35
1" - 1 1/4"	3/4" - 1"	7/16" UNF-20 UNF	9	80	11-9	97-80
1 1/2" - 2"	1 1/4" - 1 1/2"	9/16" UNF-18 UNF	13	115	16-13	140-115
2 1/2"	2"	M20 X 2.5	30	265	36-30	320-265
3" - 4"	2 1/2" - 4"	1"-14 UNS	60	530	72-60	637-530
6"		1 1/2"-12 UNF	120	1060	145-120	1280-1060

**Gland Nut Tightening Torque For C31C, FC31C, C32C, FC32P**

Bore	Nut Thread	PTFE Seals		* Graphite Seals	
		Nm	in.lb	Nm	in.lb
1/2" - 3/4"	3/8" UNF-24 UNF	4	35	6-4	53-35
1"	7/16" UNF-20 UNF	9	80	11-9	97-80
1 1/2" - 2"	9/16" UNF-18 UNF	13	115	16-13	140-115
3" - 4"	1"-14 UNS	60	530	72-60	637-530
6"	1 1/2"-12 UNF	120	1060	145-120	1280-1060

**Gland Nut Tightening Torque For C73C, FC73C, C74C, FC74C, C78C, FC78C, C77C, FC77C**

Bore	Nut Thread	PTFE Seals		* Graphite Seals	
		Nm	in.lb	Nm	in.lb
1/2"	3/8" UNF-24 UNF	4	35	6-4	53-35
3/4" - 1"	7/16" UNF-20 UNF	9	80	11-9	97-80
1 1/2"	9/16" UNF-18 UNF	13	115	16-13	140-115
2"	M20 X 2.5	60	530	72-60	637-530
3" - 4"	1"-14 UNS	120	1060	145-120	1280-1060
6"	1 1/2"-12 UNF	120	1060	145-120	1280-1060

\*Graphite stem seals must be torqued to the higher torque figure in the table, then cycle 8 times and re torqued to the lower torque figure.

**IMPORTANT:**

An excessively tightened gland nut can cause excessive packing wear and increase stem torque.

**TABLE 2**  
Body Bolts Tightening Torque For C47C, FC47C

Reduce Bore	Full Bore	Bolt Thread	Nm	in.lb
1/2" - 3/4"	1/2"	M8	18	160
1" - 1 1/4"	3/4" - 1"	M10	39	345
1 1/2" - 2 1/2"	1 1/4" - 2"	M12	65	575
3"	2 1/2"	1/2"-13UNC	80	708
4"	3"	M16	160	1416
	4"	M20	300	2655
6"		M20	300	2655

**Body Bolts Tightening Torque For C73C, FC73C, C74C, FC74C, C78C, FC78C, C77P, FC77C**

Bore	Bolt Thread	Nm	in.lb
1 1/2" - 2"	M12	65	575
3" - 4"	M16	160	1416
6"	M20	300	2655

**TABLE 3**  
Bonnet Bolts Tightening Torque For C47C, FC47C

Reduce Bore	Full Bore	Bolt Thread	Nm	in.lb
1/2" - 3/4"	1/2"	M5	6	55
1" - 2"	3/4" - 1 1/2"	M6	9	80
2 1/2"	2"	M10	39	345
3" - 4"	2 1/2" - 4"	M12	65	575
6"		M16	160	1416

**Bonnet Bolts Tightening Torque For C31C, FC31C, C32C, FC32C**

Bore	Bolt Thread	Nm	in.lb
1/2" - 3/4"	M5	6	55
1" - 2"	M6	9	80
3" - 4"	M12	65	575
6"	M16	160	1416

**Bonnet Bolts Tightening Torque For C73C, FC73C, C74C, FC74C, C78P, FC78C, C77C, FC77C**

Bore	Bolt Thread	Nm	in.lb
1/2"	M5	6	55
3/4" - 1 1/2"	M6	9	80
2"	M10	39	345
3" - 4"	M12	65	575
6"	M16	160	1416

**FIGURE 6**  
Body Bolt Tightening Pattern

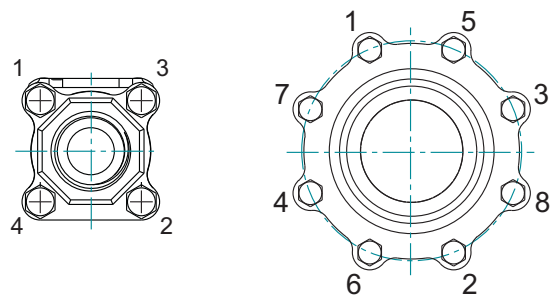

**Sizes 1/2" - 2 1/2"**

**Sizes 3" - 6"**

**C47C, FC47C 1/2"-2"**

Item	Description	Material Specifications	Qty.
1	Body	S.St. ASTM A351 CF8M	1
2	End	S.St. ASTM A351 CF3M/CF8M	2
3	Ball	S.St. ASTM A351 CF8M	1
4	Stem	S.St. ASTM A276 316/316L	1
5	Seat	TFM, NRG, PCTFE	2
6	Body seal	PTFE/Graphite	2
7	Stem Thrust seal	Carbon filled PTFE	1
8	Gland packing	Hermetix™	1
9	Follower	Stainless St. ASTM B783 316L	1
10	Disc spring	Stainless St. ASTM A693 17-7PH	2
11	Stem nut	Stainless St. ASTM A194 316	1
12	Locking clip	Stainless St. ASTM A164 304	1

Item	Description	Material Specifications	Qty.
13	Handle	Stainless St. ASTM A194 430	1
14	Serrated washer	Stainless St. AISI 410	1
15	Handle nut	Stainless St. ASTM A194 316	1
16	Sleeve	Vinyl plastisol	1
17	Stop pin	Stainless St. ASTM A582 303	1
18	Bonnet seal	PTFE/Graphite	1
19	Stem bearing	PTFE	1
20	Body bolt	Stainless St. ISO 4014 A2-70	8
21	Spring washer	DIN 127 A2	8
22	Bonnet bolt	Stainless St. ISO 4014 A2-70	4
23	Spring washer	DIN 127 A2	4
24	Bonnet	Stainless St. ASTM A276 316L	1
25	Flow arrow	Stainless St. ASTM A167 304	2

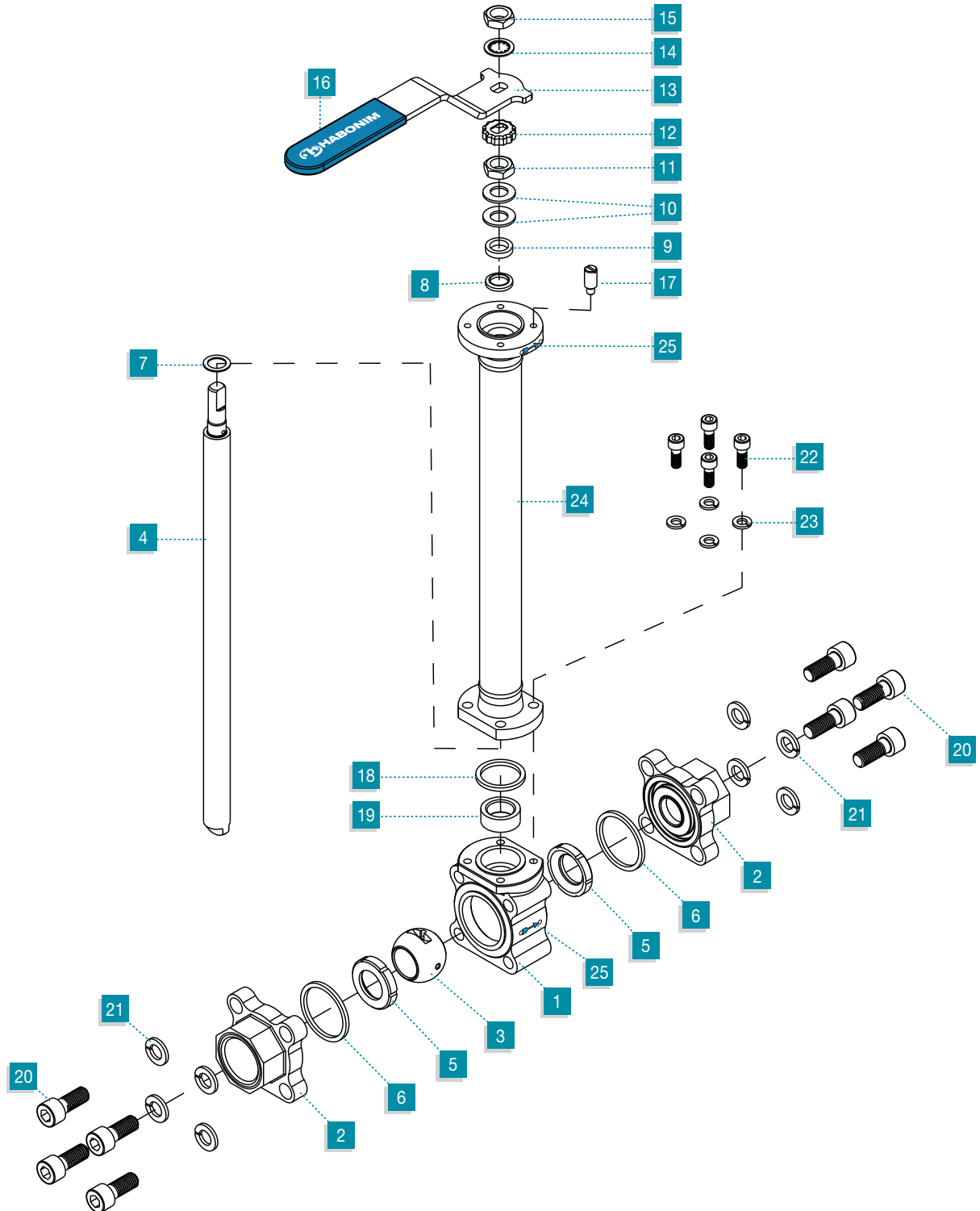



**C47C, FC47C 2½"-6"**

Item	Description	Material Specifications	Qty.
1	Body	S.St. ASTM A351 CF8M	1
2	End	S.St. ASTM A351 CF3M/CF8M	2
3	Ball	S.St. ASTM A351 CF8M	1
4	Stem	S.St. ASTM A276 316/316L	1
5	Seat	TFM, NRG, PCTFE	2
6	Seat ring	Stainless St. ASTM A276 316L	1
7	Body seal	PTFE/Graphite	2
8	Stem Thrust seal	Carbon filled PTFE	1
9	Gland packing	Hermetix™	1
10	Follower	Stainless St. ASTM B783 316L	1
11	Stopplate	Stainless St. ASTM A240 430	1
12	Tab lock washer	Stainless St. ASTM A240 304	1

Item	Description	Material Specifications	Qty.
13	Stem nut	Stainless St. ASTM A194 316	1
14	Wrench head	Stainless St. ASTM A351 CF8M	1
15	Wrench handle	Stainless St. ASTM 316L	1
16	Wrench bolt	Stainless St. AISI 304	1
17	Stop pin	Stainless St. ASTM A582 303	1
18	Bonnet seal	PTFE/Graphite	1
19	Stem bearing	PTFE	1
20	Body bolt	Stainless St. ISO 4014 A2-70	16
21	Spring washer	DIN 127 A2	16
22	Bonnet bolt	Stainless St. ISO 4014 A2-70	4
23	Spring washer	DIN 127 A2	4
24	Bonnet	Stainless St. ASTM A276 316L	1
25	Flow arrow	Stainless St. ASTM A167 304	2

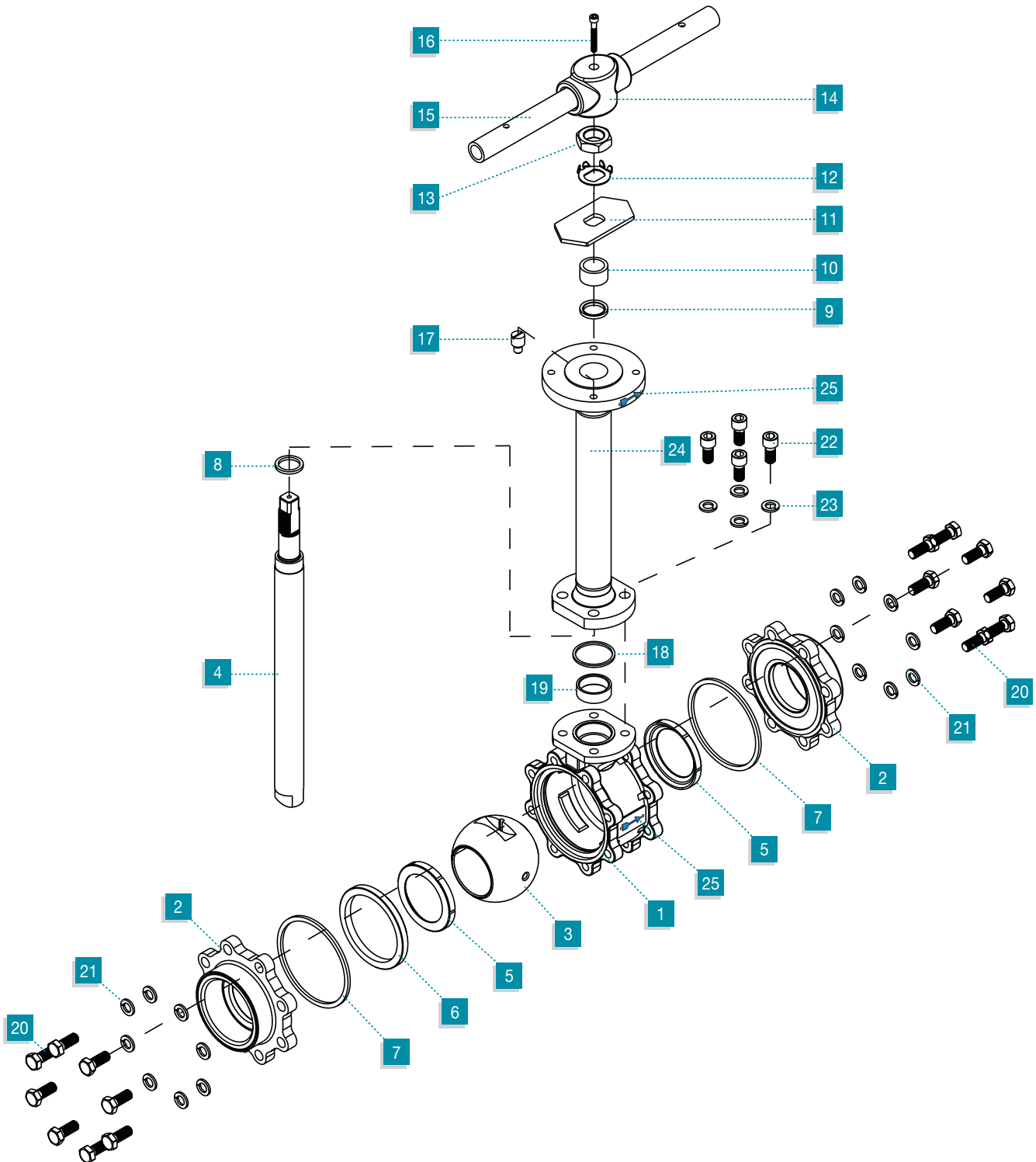

**C31C, FC31C**  
**C32C, FC32C (Size 1/2" to 6") #150 Rating**  
**C74C, FC74C (Size 1/2" to 1") #300 Rating**  
**C78C, FC78C (Size 1/2" to 1") PN40**

Item	Description	Material Specifications	Qty.
1	Body	S.St. ASTM A351 CF8M	1
2	Plug	S.St. ASTM A351 CF8M	1
3	Ball	S.St. ASTM A351 CF8M	1
4	Stem	S.St. ASTM A276 316/316L	1
5	Seat	TFM, NRG, PCTFE	2
6	Body Seal	PTFE/Graphite	1
7	Stem Thrust Seal	Carbon Filled PTFE	1
8	Gland packing	Hermetix™	1
9	Follower	Stainless St. ASTM B783 316L	1
10	Disc Spring	Stainless St. ASTM A693 17-7PH	2
11	Stem Nut	Stainless St. ASTM A194 316	1
12	Locking Clip	Stainless St. ASTM A164 304	1
13	Handle	Stainless St. ASTM A194 430	1
14	Serrated Washer	Stainless St. AISI 410	1

Item	Description	Material Specifications	Qty.
15	Handle Nut	Stainless St. ASTM A194 316	1
16	Sleeve	Vinyl Plastisol	1
17	Stop Pin	Stainless St. ASTM A582 303	1
18	Bonnet Seal	PTFE/Graphite	1
19	Stem Bearing	PTFE	1
20	Bonnet Bolt	Stainless St. ISO 4014 A2-70	4
21	Spring Washer	DIN 127 A2	4
22	Bonnet	Stainless St. ASTM A276 316L	1
23	Stop Plate	Stainless St. ASTM A240 430	1
24	Tab Lock Washer	Stainless St. ASTM A240 304	1
25	Stem Nut	Stainless St. ASTM A194 316	1
26	Wrench Head	Stainless St. ASTM A351 CF8M	1
27	Wrench Handle	Stainless St. ASTM 316L	1
28	Wrench Bolt	Stainless St. AISI 304	1
29	Flow arrow	Stainless St. ASTM A167 304	2

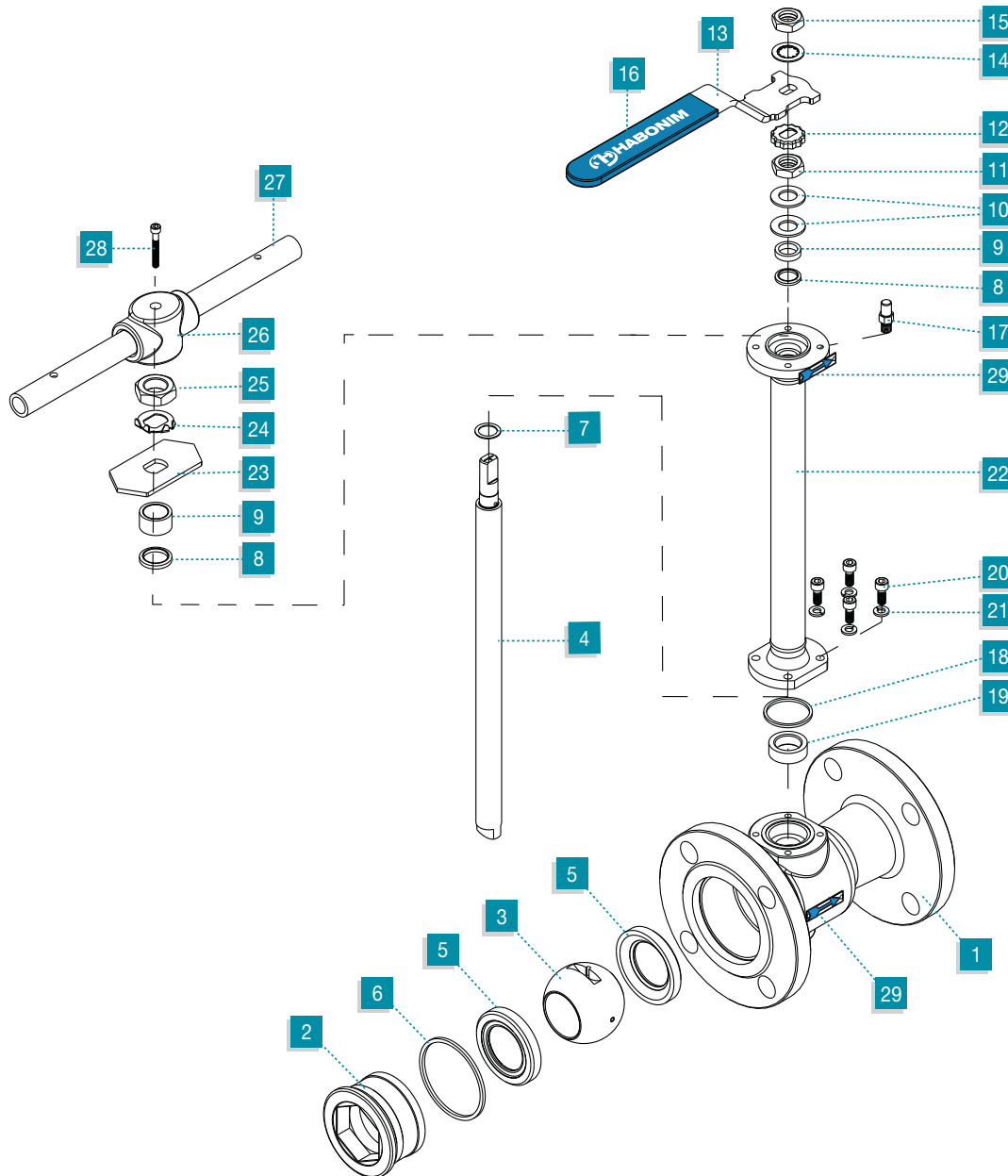

**C73C, FC73C (Size 1½" to 6") #150 Rating**  
**C74C, FC74C (Size 1½" to 6") #300 Rating**  
**C78C, FC78C (Size 1½", 2") PN40**  
**C77C, FC77C (Size 3", 4", 6") PN16**

Item	Description	Material Specifications	Qty.
1	Body	S.St. ASTM A351 CF8M	1
2	End	S.St. ASTM A351 CF8M	1
3	Ball	S.St. ASTM A351 CF8M	1
4	Stem	S.St. ASTM A276 316/316L	1
5	Seat	TFM, NRG, PCTFE	2
6	Body Seal	PTFE/Graphite	1
7	Stem Thrust Seal	Carbon Filled PTFE	1
8	Gland packing	Hermetix™	1
9	Follower	Stainless St. ASTM B783 316L	1
10	Disc Spring	Stainless St. ASTM A693 17-7PH	2
11	Stem Nut	Stainless St. ASTM A194 316	1
12	Locking Clip	Stainless St. ASTM A164 304	1
13	Handle	Stainless St. ASTM A194 430	1
14	Serrated Washer	Stainless St. AISI 410	1
15	Handle Nut	Stainless St. ASTM A194 316	1

Item	Description	Material Specifications	Qty.
16	Sleeve	Vinyl Plastisol	1
17	Stop Pin	Stainless St. ASTM A582 303	1
18	Bonnet Seal	PTFE/Graphite	1
19	Stem Bearing	PTFE	1
20	Body Bolt	Stainless St. ISO 4014 A2-70	4-8-12
21	Spring Washer	DIN 127 A2	4-8-12
22	Bonnet Bolt	Stainless St. ISO 4014 A2-70	4
23	Spring Washer	DIN 127 A2	4
24	Bonnet	Stainless St. ASTM A276 316L	1
25	Stop Plate	Stainless St. ASTM A240 430	1
26	Tab Lock Washer	Stainless St. ASTM A240 304	1
27	Stem Nut	Stainless St. ASTM A194 316	1
28	Wrench Head	Stainless St. ASTM A351 CF8M	1
29	Wrench Handle	Stainless St. ASTM 316L	1
30	Wrench Bolt	Stainless St. AISI 304	1
31	Flow arrow	Stainless St. ASTM A167 304	2

